

# XRISM Media Kit



---

# Introduction

With just 60 years of history, X-ray astronomy is a relatively new field compared with the several thousands of years we have been studying astronomy. However, even in its short history, X-ray astronomy has already provided the world with new views of the universe, including observations of previously unknown objects, such as black holes and neutron stars, and the discovery of intergalactic high-energy plasmas. X-ray astronomy has introduced observational techniques that reveal new aspects of the universe. The X-ray microcalorimeter instrument the X-Ray Imaging and Spectroscopy Mission (XRISM) carries, called Resolve, is another instrument that will greatly add to this growing history.

The objective of XRISM is to reveal the universe in X-rays, exploring new cosmic frontiers in the field of X-ray astronomy. XRISM will expand on advanced technologies from previous JAXA missions, including a state-of-the-art spectrometer with 30 times higher energy resolution than conventional spectrometers. Utilizing new capabilities and implementing lessons learned from past missions, JAXA is working with NASA, ESA, domestic and international universities, and research institutes to achieve state-of-the-art science with high reliability.

XRISM will be an X-ray observatory available to the international scientific community. XRISM will investigate the structural formation of the universe and the evolution of galaxy clusters, the history of material circulation in the universe, and energy transport and circulation in the universe. In addition, the mission will aim to pioneer new science using ultra high-resolution X-ray spectroscopy.

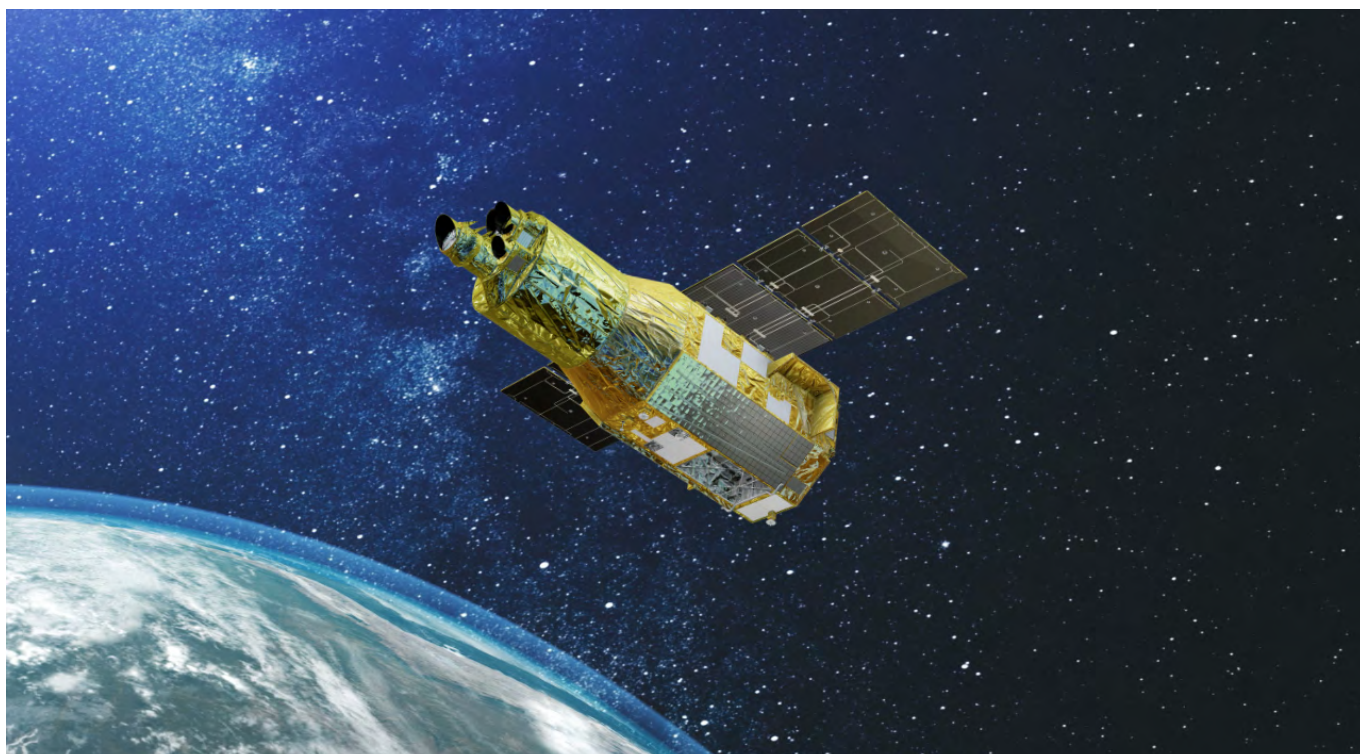

---

# Contents

<b>Introduction</b>	02
<b>Products</b>	04
<b>XRISM Overviews</b>	
Science	05
at a glance	06
Orbit	07
Mission Instruments	08
Operation Framework	09
Schedule	10
Open Use Observatory	11
<b>XRISM in the World</b>	13
<b>Science Objectives</b>	
Why we observe the Universe in X-ray?	15
The Assembly of Clusters of Galaxies	16
The Chemical Makeup of the Universe	17
The Extremes of Spacetime	18
<b>Satellite</b>	
Architecture	19
Bus Components	20
<b>Mission Instruments</b>	
XMA	21
Resolve	23
Xtend	25
<b>Science Operation</b>	
Toward Creating Scientific Results	27
Satellite Operations and Ground Systems	29
<b>XRISM Team</b>	30

Cover Images  
Crab Nebula ©X-ray: NASA/CXC/SAO/F.Seward; Optical: NASA/ESA/ASU/J.Hester & A.Loll; Infrared: NASA/JPL-Caltech/Univ. Minn./R.Gehrz  
MACS J0416 ©X-ray: NASA/CXC/SAO/G.Ogrea et al.; Optical: NASA/STScI; Radio: NRAO/AUI/NSF  
M87 ©X-ray: NASA/CXC/Villanova University/J. Neilsen  
black-hole driven outflows and jets at the centre of a galaxy ©ESA/AOES Medialab  
Tycho's Supernova ©X-ray: NASA/CXC/RIKEN & GSFC/T. Sato et al; Optical: DSS

---

# Products

## News Releases and Features

### JAXA Press Releases

---

<https://global.jaxa.jp/press/2023/>

### Official Twitter

---

[https://twitter.com/JAXA\\_en](https://twitter.com/JAXA_en)

[https://twitter.com/XRISM\\_jp](https://twitter.com/XRISM_jp)

### Multimedia Resources

---

JAXA Digital Archives

<https://jda.jaxa.jp/en/>

NASA Science Visualization Studio

<https://svs.gsfc.nasa.gov/>

### Web Resources

---

Official JAXA Site

<https://global.jaxa.jp/>

Official Project Site

<https://xrism.isas.jaxa.jp/en/>

#### Official Partner Site

National Aeronautics and Space Administration (NASA)

<https://www.nasa.gov/xrism>

European Space Agency (ESA)

<https://www.cosmos.esa.int/web/xrism>

---

# XRISM Overviews

## Science

XRISM (X-Ray Imaging and Spectroscopy Mission) is Japan's seventh X-ray observatory. It will be launched by an HII-A rocket from the Tanegashima Space Center in Kagoshima Prefecture in 2023. XRISM will observe very high-temperature gases in space, ranging from hundreds to tens of millions of degrees Celsius. The XRISM payload consists of two instruments, Resolve and Xtend.

Resolve is a soft X-ray spectrometer that pairs a lightweight X-ray Mirror Assembly (XMA) with an X-ray calorimeter spectrometer that can measure the "color" of X-rays in detail. Xtend is a soft X-ray imager that can observe an area of the sky equivalent to one full moon at a time.

XRISM's most outstanding feature is its ability to distinguish color. It is particularly well suited for astrophysical analysis of extended objects such as galaxy clusters and supernova remnants.

Based on the features of the onboard instruments, XRISM has four themes of exploration.

### 1. Structure formation of the universe and evolution of galaxy clusters

---



X-ray: NASA/CXC/ITA/INAF/J.Merten et al, Lensing: NASA/STScI; NAOJ/Subaru; ESO/VLT, Optical: NASA/STScI/R.Dupke

In a galaxy cluster, 90% of the "normal" matter is hot gas at tens of millions of Kelvin. Observations of high-temperature gas are essential to understanding how the structure of the universe evolves.

### 2. History of the material cycle of the universe

---



X-ray: NASA/CXC/Penn State Univ./L. Townsley et al.; IR: NASA/ESA/CSA/STScI/JWST ERO Production Team

From interstellar gas that forms new stars to the enriched gas freed from massive stars in supernova explosions, matter circulates in the universe. By studying the motion of high-temperature gas, we can investigate how matter spreads through interstellar space.

### 3. The energy transport in the universe

---

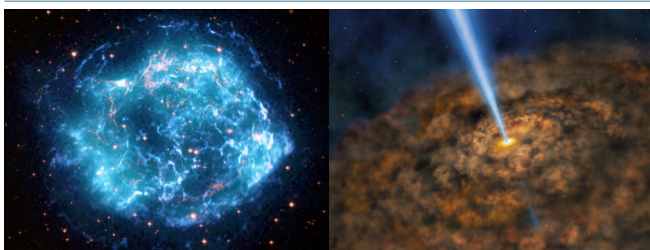

X-ray: Chandra: NASA/CXC/SAO, IXPE: NASA/MSFC/J. Vink et al.; Optical: NASA/STScI NASA

Matter and energy are transported into interstellar and intergalactic space by energetic phenomena, such as supernova explosions and active galactic nuclei. X-ray spectroscopy of these hot and intense phenomena can help us understand the transport processes.

### 4. Pioneering new science with unprecedented high-resolution X-ray spectroscopy

---

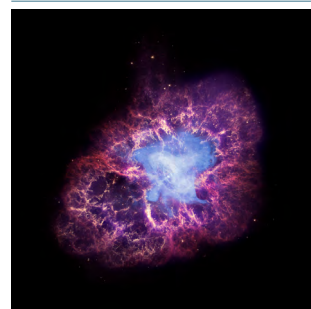

X-ray: NASA/CXC/SAO/F.Seward; Optical: NASA/ESA/ASU/J.Hester & A.Loll; Infrared: NASA/JPL-Caltech/Univ. Minn./R.Gehrz

Researchers cannot create strong gravitational and magnetic fields in the laboratory that often occur throughout the universe. XRISM's capabilities will also allow us to understand better how matter behaves under "extreme conditions."

# XRISM Overviews

## at a glance

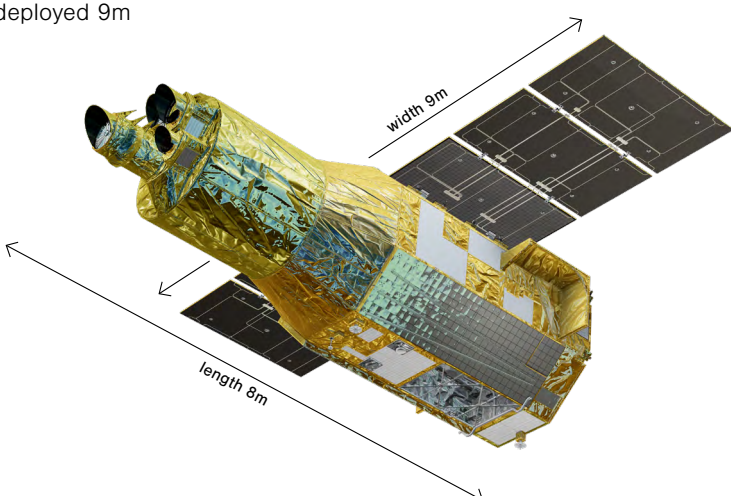
Name	XRISM (X-Ray Imaging and Spectroscopy Mission)	
Goals and Objectives	<p>Building on previous missions and technologies, XRISM will continue to elucidate the processes of matter circulation and energy transport in the high-temperature regions of the universe, as well as the evolution of astronomical objects. In particular, XRISM will study how:</p> <ol style="list-style-type: none"> <li>Cosmic structures form, and galaxy clusters evolve in the universe</li> <li>Matter has circulated in the universe over time</li> <li>Energy transports and circulates throughout the universe</li> <li>To pioneer new scientific discoveries using ultra-high resolution X-ray spectroscopy</li> </ol>	
Launch	Targeted Date	August 26, 2023
	Launch Site	Tanegashima Space Center
	Launch Vehicle	H-IIA rocket
Structure	Dimensions	<p>Total length 8m Width with solar arrays deployed 9m Diameter 3m</p> 
	Mass	2.3 t
Orbit	Altitude	550 +/- 50 km
	Inclination	31 degrees
	Type	Circular
	Period	96 minutes
Instruments	<p>Xtend (Soft X-ray imager) Resolve (Soft X-ray spectrometer)</p>	

# XRISM Overviews

## Orbit

XRISM has a circular orbit around Earth with an inclination of 31 degrees at a height of about 550 km. Each orbit takes about 96 minutes. XRISM's attitude is controlled with an accuracy of approximately 17 arcseconds. The STT (Star Tracker Telescope) camera captures images of point-source stars, and the satellite's pointing direction is estimated based on these images. The Reaction Wheels (RW) maintain or change the direction of XRISM.

XRISM observes a single object for a certain period of time. When the observation of a target object is completed, XRISM slews to the next target object according to an operations plan prepared in advance.

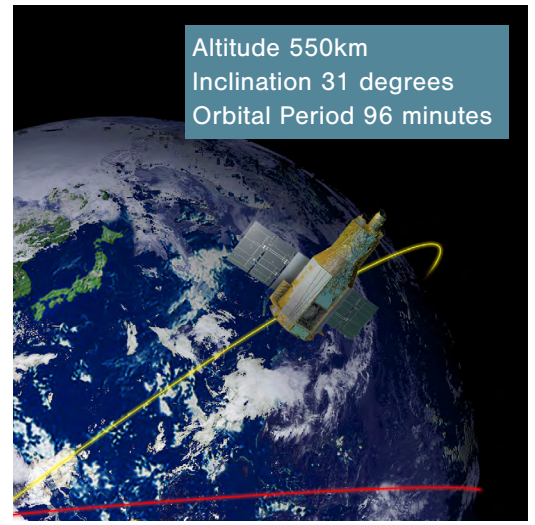

XRISM's Orbit

Communication with XRISM in orbit is mainly performed using the 34m/20m antennas at the Uchinoura Space Center (USC) in Kagoshima Prefecture and the 20m antenna at the Katsura Space Communication Station in Chiba Prefecture. Overseas stations will also be used to monitor the satellite status. The S-band (2 GHz band) and the X-band (8 GHz band) are used for communication with the satellite. The S-band is more stable and is used to transmit satellite control commands and receive housekeeping information (power, temperature, attitude, etc.). The X-band is about four times faster than the S-band and is used for receiving sizeable scientific observation data.

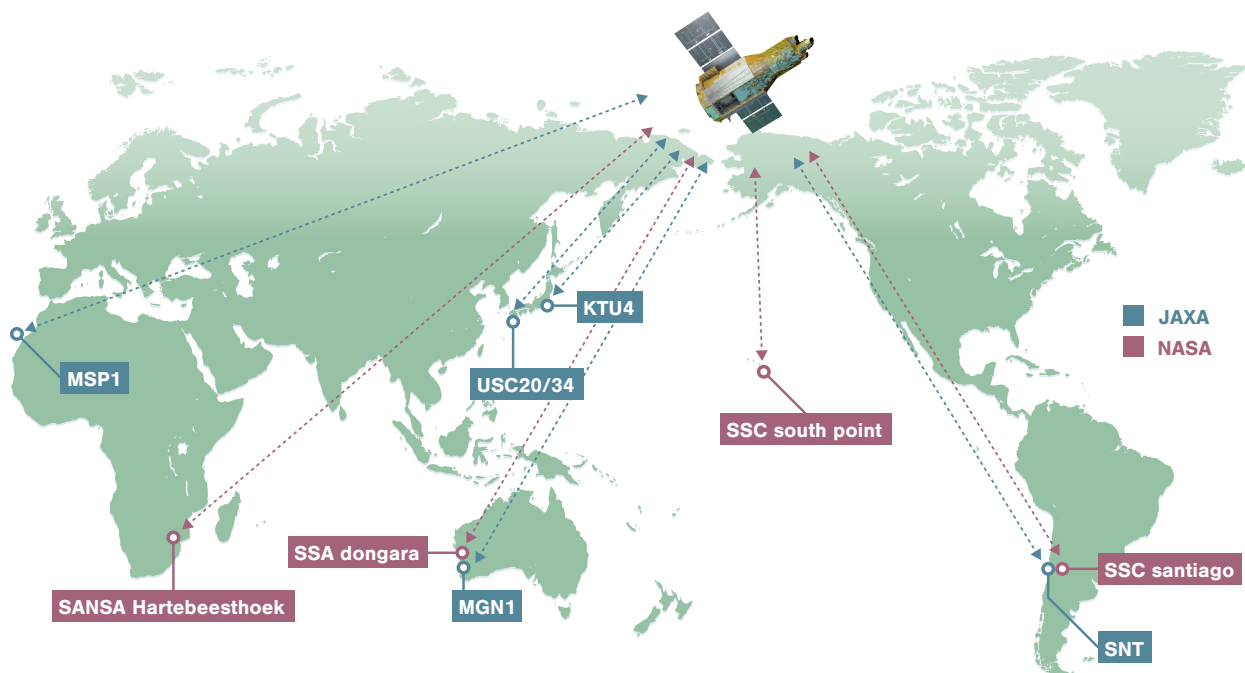

Ground Stations for the XRISM's operations

---

# XRISM Overviews

## Mission Instruments

XRISM is equipped with Resolve for ultra-precise energy measurement and Xtend for imaging over a wide wavelength range. XMA (X-ray Mirror Assembly) is an X-ray telescope that efficiently collects X-rays at the sensor.

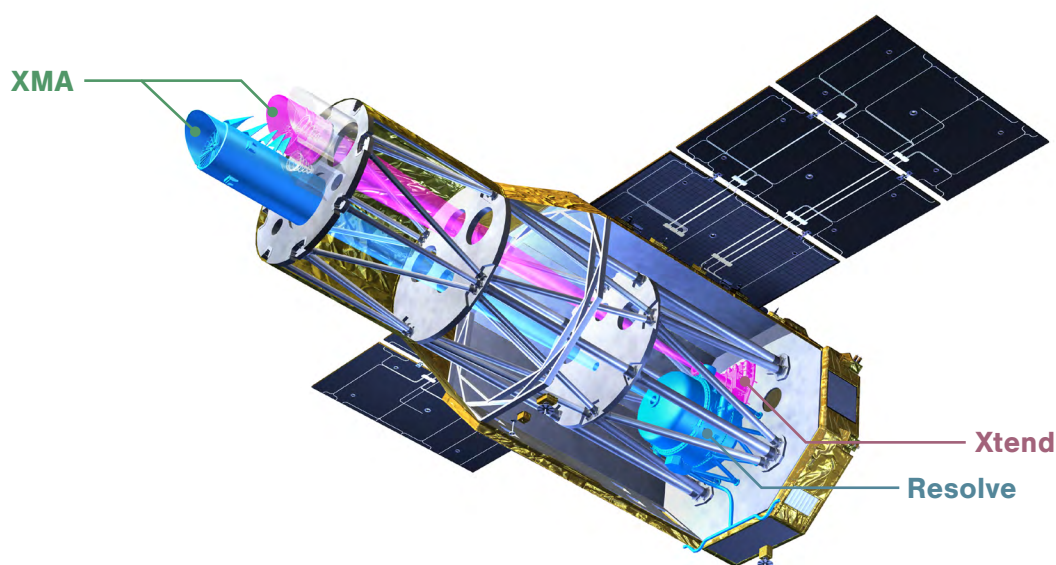

### **XMA (X-ray Mirror Assembly)**

XMA is an X-ray telescope. X-rays entering the telescope will encounter the mirror's smooth metal shells at a very shallow angle, called grazing incidence. They'll experience total reflection, which will slightly change their direction of travel, focusing them on a detector. The mirrors of XMA are nested one within another, like an onion, to guide X-rays as much as possible to the focal point.

### **Resolve**

Resolve will measure the amount of incoming X-ray energy in great detail, enabling us to measure the temperature and composition of X-ray-emitting objects with great precision. In addition, researchers can use the Doppler effect, a phenomenon where wavelengths of light emitted by a moving object appear to be shifted, to determine the object's motion. Resolve was developed jointly by Japan and the United States.

### **Xtend**

Xtend will make images from the X-rays coming from celestial objects. The CCD camera used in Xtend is not so different from that of ordinary digital cameras. However, the Xtend camera's CCD is designed to detect X-rays and measure their energies.



# XRISM Overviews

## Operation Framework

XRISM is a joint international project that JAXA is pursuing under a memorandum of understanding with the National Aeronautics and Space Administration (NASA) and the European Space Agency (ESA). In addition to the three space agencies, JAXA has been working closely with universities and research institutes in Japan, the U.S., and Europe to develop satellites, instruments, and data-processing software.

More than 300 astrophysicists and engineers from the three space agencies, universities, and research institutes in Japan, the U.S., and Europe are participating in the project to develop satellites, instruments, data processing software, and scientific observation plans.

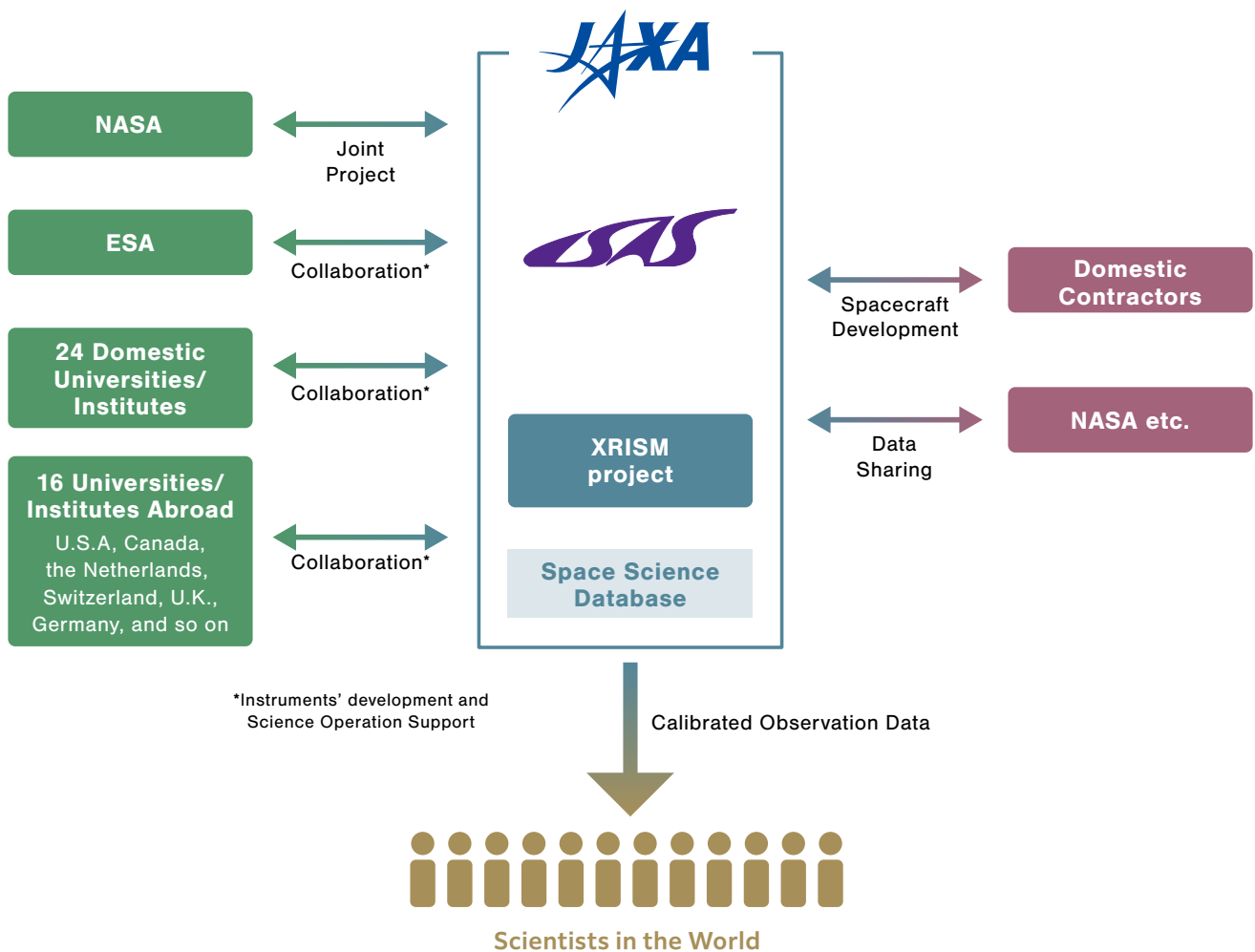

# XRISM Overviews

## Schedule

### Post-launch Sequence

XRISM is launching on the H-IIA Launch Vehicle as a joint ride with the Smart Lander for Investigating Moon (SLIM). The right figure shows the planned trajectory of the XRISM spacecraft after launch. XRISM will be inserted into an orbit circulating Earth at a height of 550 km with a period of 96 minutes.

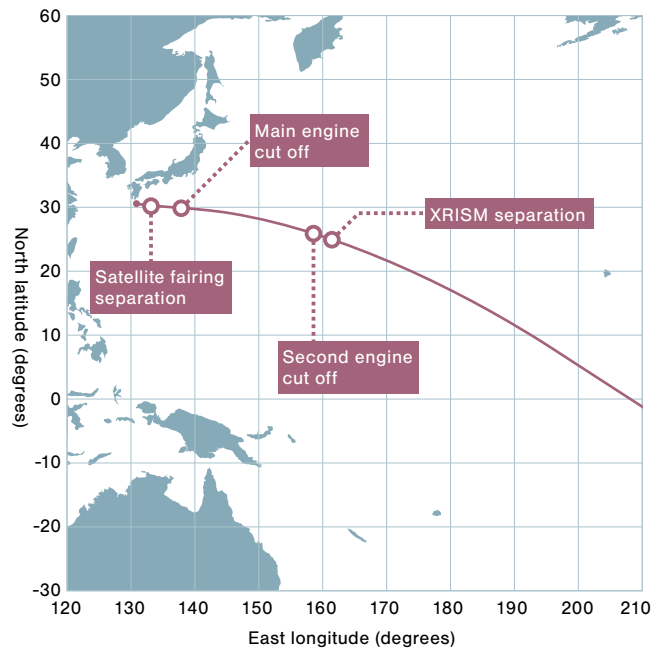

### Schedule after the Orbit Injection

After the orbital insertion, the initial phase is divided into two phases: a critical operation phase to confirm whether the satellite can maintain its attitude and a commissioning phase to test the operation of the subsystems. After the initial phase, there will be a Performance Verification phase (PV phase) of about seven months to evaluate the performance of the detectors. Once the initial and PV phases are complete, scientific observations will begin based on researchers' proposals worldwide. When XRISM has completed nearly two years of guest observations, it will be evaluated for possible extended operations and observations (Late phase).

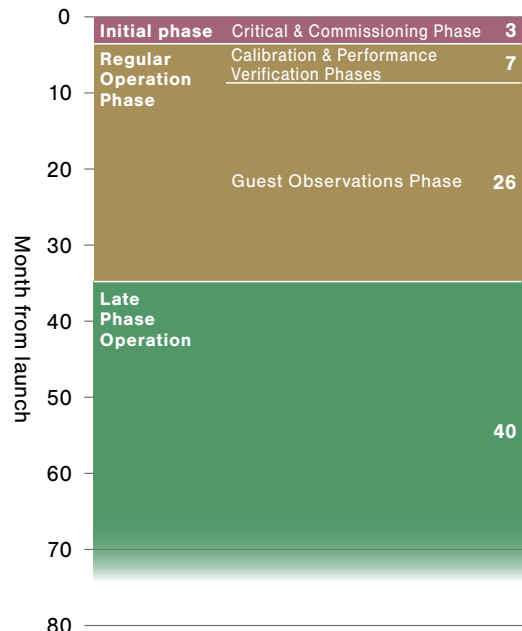

---

# XRISM Overviews

## Open Use Observatory

### **Open Use for Worldwide Scientists**

An observatory with publicly accessible data, XRISM will hold an international open call for observations to start about 10 months after launch. Experts will review the submitted proposals, and observation time will be allocated to the selected observation proposals.

After a certain period, all acquired data will be made publicly available. In this way, we aim to maximize the scientific results from XRISM.



First XRISM Core-to-Core Science Workshop ©Saitama University

### **XRISM Observation Data**

As an open-use observatory, we have adopted NASA's global standard format to make XRISM observation data widely available so that anyone who has learned how to use the software can obtain scientific results. Analysis software is available free of charge.

### **As the world's open observatory**

XRISM is an open-use observatory that observes cosmic X-rays with state-of-the-art technology. A user support team was organized to maximize the scientific results by fully utilizing XRISM's capabilities. The role of this team is to support XRISM users. The user support team has the following three roles:

1. To properly inform prospective observers of the features of XRISM and the high performance and limitations of the onboard instruments.
2. To inform users how to analyze XRISM data.
3. To present XRISM results published in papers to scientists and people interested in astrophysics worldwide.

We are putting in place a system where many scientists can use XRISM data to produce a wide variety of scientific results.



# XRISM in the World

## International Collaboration

X-ray astronomy has advanced significantly since the end of the 20th century and into the 21st century with the launch of many X-ray astronomy satellites with complementary abilities. The Chandra X-ray Observatory satellite from the United States and the XMM-Newton satellite from Europe both launched in 1999 and were each equipped with X-ray mirrors that produced the largest light-collecting area in the history of X-ray astronomy. In addition to having X-ray CCD cameras, each satellite has a dispersive spectrometer with excellent spectral performance in the low-energy band. However, neither has a high-resolution spectrometer that is capable of imaging. In 2012, the U.S. launched the NuSTAR telescope, enabling hard X-ray imaging. More recently, the U.S. IXPE satellite launched in 2021 is expanding our understanding of X-ray polarization. Each of these X-ray astronomy satellites adds new capabilities to how we understand the X-ray sky.

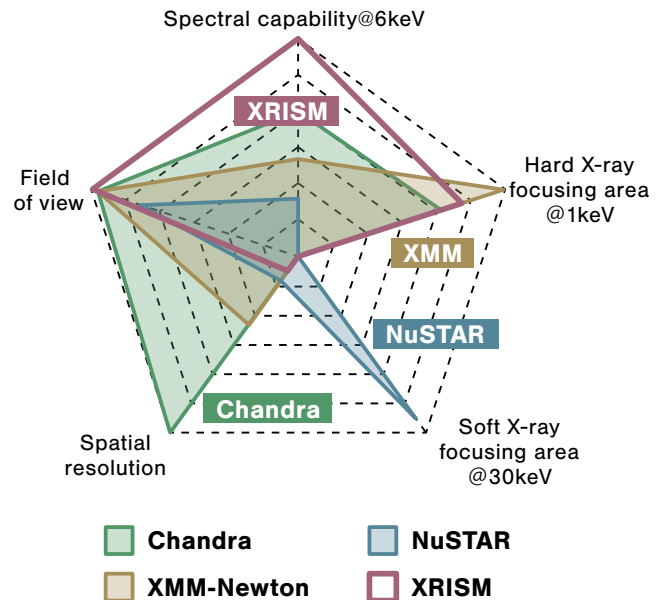

Comparison of the specialties of X-ray astronomical satellites in orbit

Scientists around the globe are anticipating the emergence of the high-precision X-ray spectral observations expected with XRISM.

Featuring a cutting-edge X-ray microcalorimeter and CCD camera, XRISM will enable astronomers to observe the X-ray universe in revolutionary new detail. Compared with previous technologies, the improved spectral resolution with XRISM is equivalent to describing the world in fewer than 100 colors or more than 2,000 colors. XRISM's highly accurate measurements will reveal the temperature, ionization state, and velocity of the rarefied, high-temperature gas (plasma) that makes up the bulk of matter in the universe, providing critical new clues to the many mysteries of space physics.

The XRISM mission is a joint JAXA-NASA partnership with support from astronomers worldwide. The spacecraft and the instruments have been developed by the three space agencies of Japan, the United States, and Europe. More than 150 astronomers from Japan, the U.S., and Europe participated in the project to plan the mission's initial observations. They have been working on a detailed observation plan since the project's inception. After six months of initial observations, XRISM will be used as a general-purpose X-ray observatory and will be open for public observations.

## History of X-ray Astronomy Spacecrafts in Japan

With 40 years of launching X-ray astronomy spacecraft, Japan has been consistently contributing to the world of X-ray astronomy. Observatory instruments with the latest technology have been launched in the past 6 spacecraft, providing new and never before seen views of the universe.

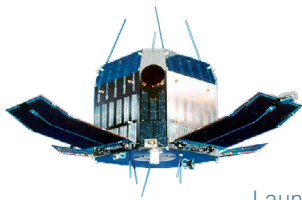

### Tenma 1983

(Pegasus in Japanese)  
Launched:1983 / Ended:1988

The newly developed gas scintillation proportional counter doubled the possible energy resolution, enabling more detailed spectroscopy of X-ray sources. One of the main outcomes of this was the discovery of X-ray emission from hot plasma along the Galactic ridge. This emission has been observed by succeeding spacecraft to elucidate the origin and nature of this emission. It remains one of the most important research themes in X-ray astronomy to this day.

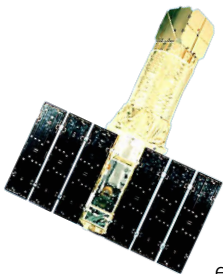

### ASCA 1993

(Flying bird)  
Launched:1993 / Ended:2001

The first satellite to carry an X-ray telescope and X-ray CCD camera, dramatically improving sensitivity. Major contributions included the detection of general relativistic effects near black holes through observations of active galactic nuclei, providing direct evidence to support the existence of supermassive black holes at the centers of galaxies. International public observations were begun for the first time, and ASCA data has been opened to and used by scientists worldwide, with a number of thesis projects supported.



### ASTRO-H 2016

Launched:February 2016  
/ Ended:March 2016

Four distinct instruments were included to explore the mysteries of dark matter and the co-evolution of galaxies and black holes, which controls the growth of structure in the universe. The mission was terminated only a month after launch due to a mishap; however, ASTRO-H achieved revolutionary measurements of the speed of plasma in galaxy clusters and the abundance of heavy elements.

### 1979 Hakucho

(swan in Japanese)

Launched:1979 / Ended:1985

Japan's first X-ray astronomy spacecraft, named after the black hole "Cygnus X-1". A modulation collimator, invented by Dr. Minoru Oda (the author of the black hole thesis in 1971 and later, Director of ISAS), was loaded onto the satellite, allowing the location of X-ray sources to be determined with high accuracy. A number of new X-ray bursts were found by this spacecraft, and this mission moved Japanese X-ray astronomy to the forefront internationally.

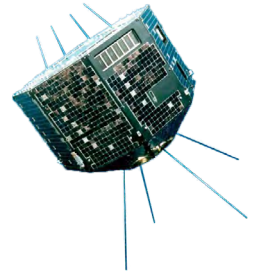

### 1987 Ginga

(Galaxy in Japanese)

Launched:1987 / Ended:1991

New instrumentation included high sensitivity detectors. Major outcomes included the X-ray detection of supernova 1987A shortly after the commencement of observations, and the discovery of many candidate black holes. A full-scale international collaboration begun with this spacecraft to develop the instruments with researchers from all over the world. Dr. Masatoshi Koshiha detected neutrinos from supernova 1987A using Kamiokande in Gifu prefecture, and was later awarded the Nobel Prize in Physics for this discovery.

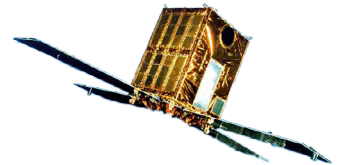

### 2005 Suzaku

(Legendary bird, the guardian of the universe)

Launched:2005 / Scientific observations ended 2015.

An X-ray telescope with higher sensitivity than ASCA and instruments to cover a wider bandpass. The major contributions of Suzaku were to detect non-equilibrium ionized plasma in supernova remnants, research into cosmic-ray acceleration mechanisms by shock waves, the detection of X-ray reflection nebulae, detection of active galactic nuclei, elucidating the evolution of galaxy clusters by observing the heavy element distribution in their outer regions, and the X-ray emission from magnetars (highly magnetized neutron stars)



# Science Objectives

## Why do we observe the Universe in X-rays?

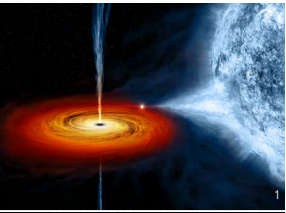

The XRISM mission's objective is to observe high-temperature plasma in the universe. Cosmic objects composed of this plasma exist at temperatures above 1 million kelvin (K). By observing high-temperature plasmas, we can study black holes, neutron stars, white dwarfs, supernova remnants, clusters of galaxies, and large groups of galaxies.

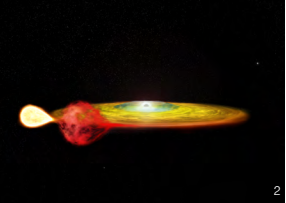

The processes that generate shorter wavelengths of electromagnetic radiation, or light, require higher energy (temperatures). X-rays, which have shorter wavelengths than visible and ultraviolet light, are mainly emitted from materials hotter than a star's surface, around 1 to 100 million K. Such high-temperature materials are in a plasma state as ionized gas. A high-temperature plasma that emits X-rays can spread very quickly, requiring a strong gravitational force to keep it from dissipating. Individual objects such as white dwarfs, neutron stars, and black holes, which are very small and heavy, attract hot plasma. Galaxies and galaxy clusters are also strong gravitational sources with high-temperature plasmas. Observing X-ray spectra allows astronomers to study this hot plasma. Measuring characteristic X-ray energies specific to the elements in the plasma allows researchers to analyze its elemental composition and ionization state.

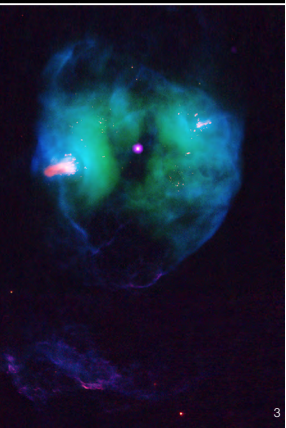

**XRISM** is an X-ray astronomy observatory that simultaneously records X-ray images and spectra. XRISM has two X-ray instruments, **Resolve** – an X-ray microcalorimeter, and **Xtend** – an X-ray CCD camera.

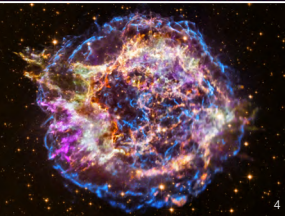

**Resolve** is more than 20 times more accurate in measuring the energies of individual X-ray photons than previous instruments. This resolution represents a breakthrough in X-ray instrument performance. Observing at such a high resolution enables astronomers to detect rare elements in high-temperature plasmas and to measure Doppler shifts due to plasma motion and gravitational fields with unprecedented precision.



**Xtend** has a wider field of view (38 arcmin square vs. 3 arcmin square for **Resolve**) and can therefore capture larger celestial objects and their surroundings. **Xtend's** technology has been used in observatories for nearly 30 years, and its performance in orbit is well known.



1.NASA/CXC/M.Weiss 2.NASA/CXC/M. Weiss 3.X-ray: NASA/CXC/RIT/SAO/J.Kastner; Optical: NASA/ESA/AURA/STScI/Univ. Washington, B.Balick  
4.X-ray: NASA/CXC/RIKEN/T. Sato et al.; Optical: NASA/STScI 5.X-ray: NASA/CXC/SAO; UV: NASA/JPL-Caltech; Optical: NASA/STScI; IR: NASA/JPL-Caltech  
6.X-ray: NASA/CXC/Univ. of Chicago, I. Zhuravleva et al, Optical: SDSS

---

# Science Objectives

## The Assembly of Clusters of Galaxies

How have celestial objects in the universe been formed?

Dark matter, a mysterious and unseen material, fills the universe. Astronomers think the gravitational force of dark matter led to the formation of the Milky Way galaxy and other celestial bodies. Researchers also think the gravity of dark matter causes repeated collisions and mergers, creating more massive objects. The largest of these objects are clusters of galaxies that are still growing. The mass of a galaxy cluster is 1,000 trillion times the mass of the Sun, and more than 80% of it is composed of dark matter. In a galaxy cluster, most of the ordinary matter we can detect, such as hydrogen, fills the cluster as a superheated gas at tens of millions Kelvin. The mass that's found in stars is just a few percent of the total mass of the galaxy clusters.

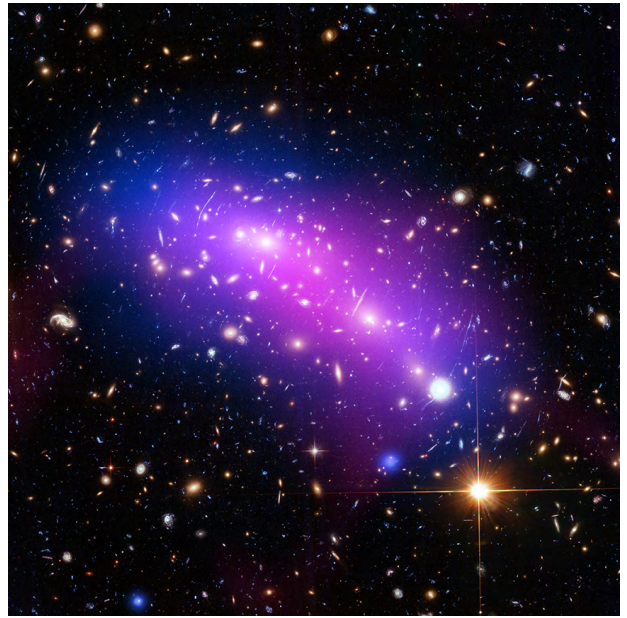

Galaxy cluster MAXS J0416 in multi wavelength  
X-ray: NASA/CXC/SAO/G.Ogrea et al.; Optical: NASA/STScI; Radio: NRAO/AUI/NSF

XRISM will feature the first instrument designed to precisely measure the velocity of the hot gas of galaxy clusters using X-rays. The large mass of the dark matter also causes the motion of the gas and galaxies to have much higher velocities than what would be caused by the normal matter. Using the X-ray emission lines created by the hot gas will allow astronomers to study its velocity, including that caused by turbulent motion. XRISM will allow us to directly observe the growth process of the largest astronomical objects in the universe, galaxy clusters.

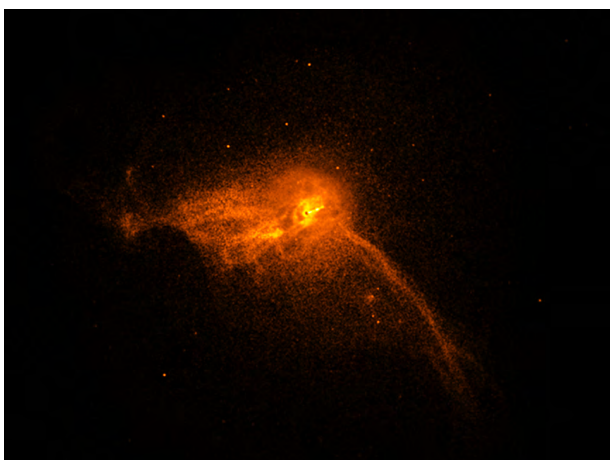

Complex structure in the hot, X-ray emitting gas from close to the black hole at the center of M87  
X-ray: NASA/CXC/Villanova University/J. Neilsen

However, dark matter is not the only heating source of gas in the centers of galaxy clusters. Galaxies typically harbor supermassive black holes billions of times the mass of the Sun. When gas falls into the black hole, part of the released gravitational energy can heat the gas surrounding the galaxies in clusters. XRISM aims to measure the velocity of the wind blowing out from the supermassive black hole at the center of galaxy clusters.



---

# Science Objectives

## The Chemical Makeup of the Universe

Shortly after the Big Bang, there was only hydrogen, helium, and a small amount of lithium. Today's universe has many more elements, such as oxygen, carbon, iron, and silicon. What was the "cosmic recipe" that led to the chemical evolution of our present-day universe? This is one of the mysteries XRISM will investigate.

During their lifetimes, stars slowly turn lighter elements into heavy ones through nuclear fusion. Heavy elements are also synthesized at the moment of a supernova, which is a large explosion at the end of a star's life. These explosions disperse the synthesized elements into space, enabling the universe to evolve new structures, including solar systems like our own.

The ejecta scattered by a supernova explosion forms a shock wave in space at supersonic speeds of several thousand kilometers per second. It expands as a ball of superheated plasma, called a supernova remnant, which shines brightly in X-rays like cosmic fireworks. Spectra obtained through observations with XRISM will allow astronomers to measure with unprecedented precision the fraction and diffusion process of elements that have been unobservable until now, helping us determine the different elemental abundances stars create.

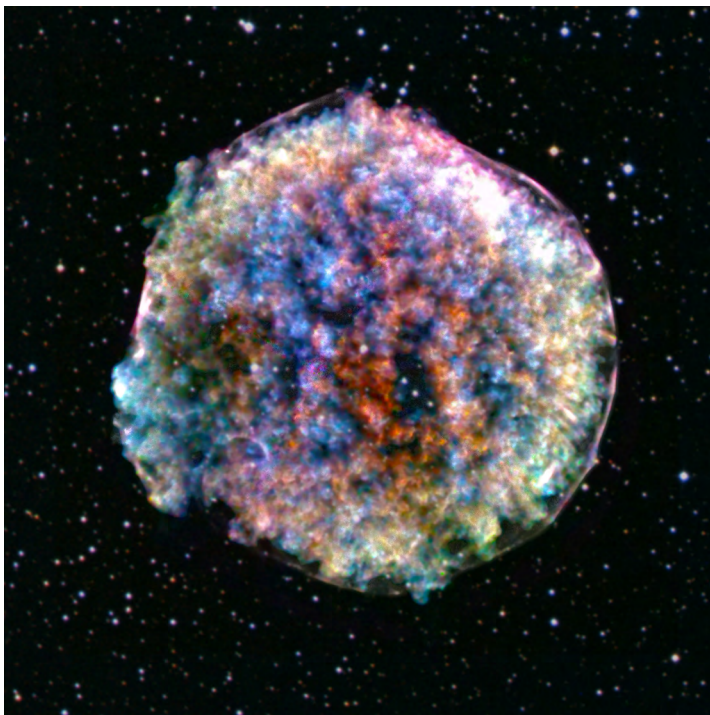

Supernova remnant SN 1572  
X-ray: NASA/CXC/RIKEN & GSFC/T. Sato et al; Optical: DSS

Heavy elements scattered in supernova remnants spread slowly through interstellar space and are recycled as materials for new stars and planets. Earth and its inhabitants are "star children" formed of materials from past stars. Heavy elements seep into intergalactic space and diffuse into the hot plasma that fills the space between galaxies in galaxy clusters. Since different stars and supernovae produce different elements, we can examine the patterns of their elemental compositions in detail, gaining new insights into billions of years of elemental synthesis and the history of the stars and supernovae that created them.

---

# Science Objectives

## The Extremes of Spacetime

So-called compact objects create conditions in space that we can't replicate on Earth. When a star burns out its fuel gas and dies, it leaves behind an extremely dense and massive object. This object could be a black hole, neutron star, or white dwarf depending on the size of the star. We also find supermassive black holes, which are millions to billions of times more massive than the Sun, at the centers of most galaxies. These "compact objects" can attract nearby gas due to their strong gravity, releasing enormous gravitational energy and emitting X-rays. By observing these X-rays, we can study the phenomena that occur in an environment of ultra-strong gravity, a process that cannot be made in a laboratory. We can use these same observations to study the state and motion of matter and obtain clues to the properties of compact objects themselves.

### **Measuring the Rotation of a Black Hole and Revealing the Structure of Spacetime**

The energy of X-rays emitted from a black hole's immediate vicinity changes due to a spacetime distortion caused by the black hole's strong gravity. The amount the X-ray energy changes depends on how fast the black hole rotates. XRISM will measure the X-ray energy from the gas just before it falls into the black hole to study the structure of spacetime. The data from XRISM will allow us to estimate the black hole's rotation velocity and verify the general theory of relativity.



Illustration of a black hole

### **Unraveling the Mechanism of Gas Ejection from Compact Objects**

Gas-swallowing black holes and neutron stars often produce narrow jets that shoot out in opposite directions at speeds close to the speed of light (about 300,000 km/s) and winds that blow out at hundreds to tens of thousands of kilometers per second. How can gas be ejected at such high speeds from a compact object whose gravity is so strong that it is supposed to pull in everything around it? The mechanism behind this process is still unknown. Elements in jets and winds absorb or emit X-rays of specific energy. By precisely measuring the intensity and energy of these absorption and emission lines, we can determine how much of each element is present and how fast the jet is moving. Astronomers hope to better understand the mechanism behind these gas eruptions by analyzing this information.

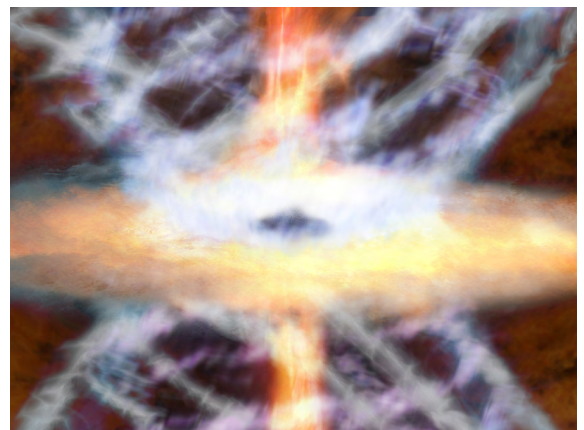

Illustration of the supermassive black hole at a galactic center  
©ESA/AOES Medialab

# Satellite Architecture

XRISM is packed with state-of-the-art X-ray equipment and satellite technology that makes the science possible.

## Structural design

To point a long spacecraft to a target object with an accuracy of less than one arcminute, the structure is designed as follows:

- Fixed Optical Bench (FOB ) on which the X-ray telescope is mounted
- Eight side panels for various instruments
- The lower structure, consists of a base panel connecting the optical bench and side panels with two types of detectors, as well as a thrust tube with a lower-end ring connecting the satellite to the launch vehicle.

The optical bench is made of low thermal distortion structural material and designed to achieve high shape stability against environmental changes in orbit.

## Thermal Design

The instruments' heat does not flow to the optical bench or base panel, where heat distortion is undesirable. Instead, the heat is exhausted from the radiant heat exchanger mounted on the side panel. In addition, many heat pipes are mounted to transport the heat.

## Position of Observational Instruments

The two X-ray telescopes are mounted on an optical bench, facing the same direction and observing the same object simultaneously. The two detector systems, which detect individual X-ray photons from the sky one at a time, are mounted on the base panel.

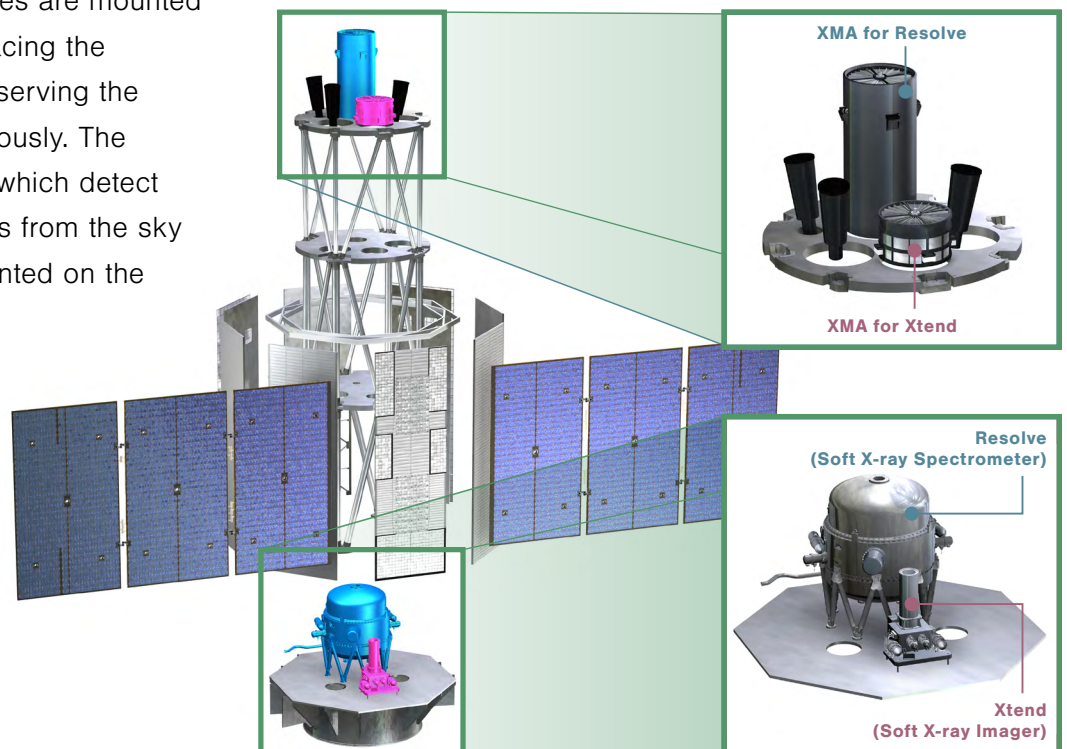

XRISM Architecture

# Satellite Bus Components

## Main Satellite System Configuration

- 1. Data processing system (DHS)**  
The DHS handles communications between devices, telemetry recording and playback, automatic, autonomous operation of the satellite, and various other processes to keep the satellite safe. It also receives GPS signals, determines time, position, and velocity, and provides time to the satellite.
- 2. Communication system (RF)**  
The satellite communication system uses S-band and X-band communication equipment to provide telemetry, command, and ranging signals necessary for satellite system operation.
- 3. Power supply system (EPS)**  
The electrical power system (EPS) provides the power necessary for satellite operation in sunshine and shade.
- 4. Attitude and Orbit Control System (AOCS)**  
The AOCS determines the spacecraft attitude and performs three-axis attitude control to point at a specified object by command. The system performs attitude change maneuvers to change the pointing direction with the attitude accuracy required by the observation equipment. It also conducts orbit control to avoid debris collisions.

## System Block Diagram

SpaceWire is a spacecraft communication network used for data communication between components on the spacecraft.

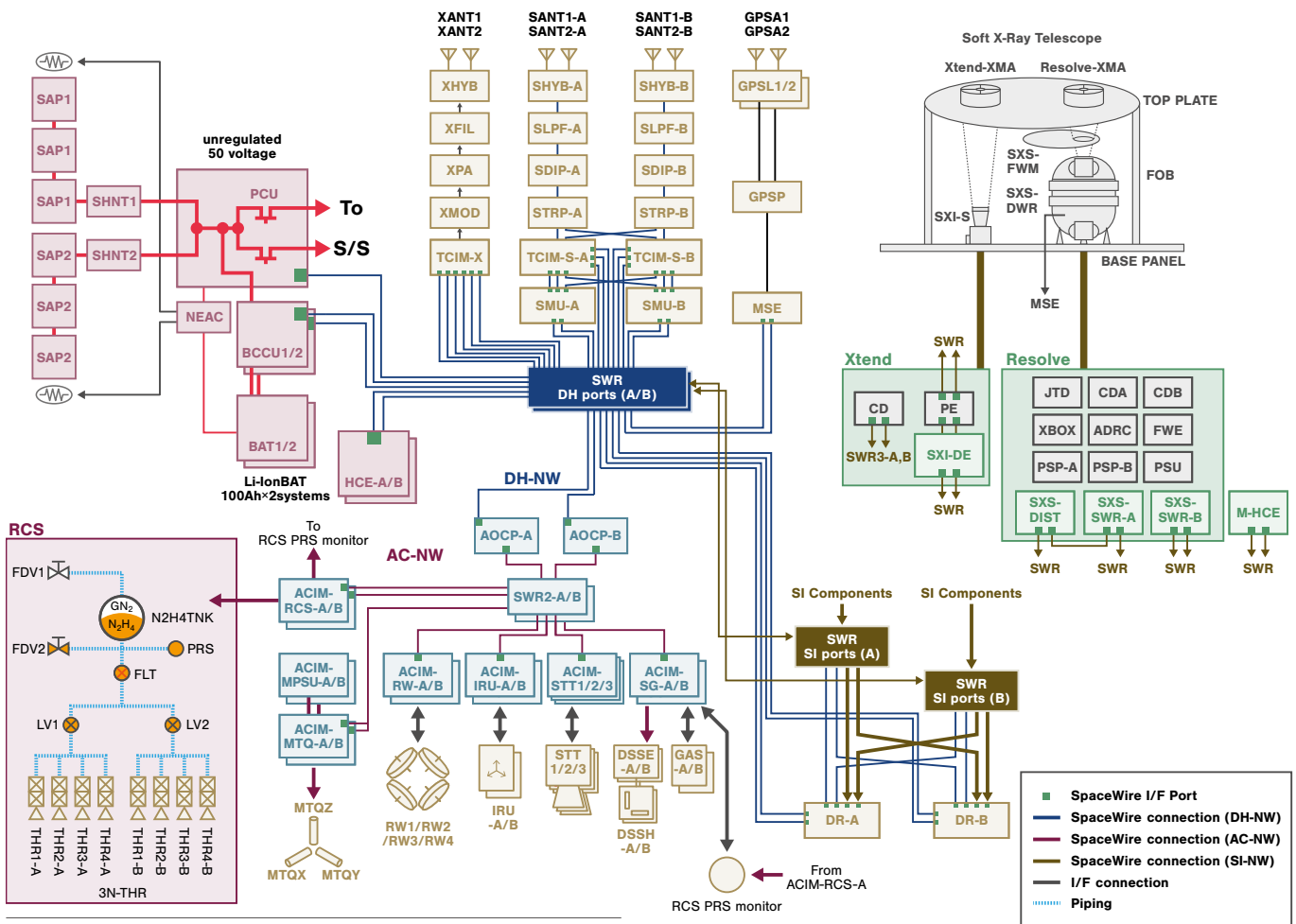

System Block Diagram

# Mission Instruments

## XMA

X-ray telescope that efficiently collects X-rays

### Basics

X-ray Mirror Assembly (XMA) is a telescope that focuses X-rays from a celestial object to obtain an image. XRISM is equipped with two identical XMAs, one for Resolve and one for Xtend.

The XMAs were developed at NASA's Goddard Space Flight Center (GSFC). Each consists of 203 thin reflector shells nested coaxially (see photo).

### Technology

The reflector aluminum substrates were made of three different thicknesses (152, 229, and 305  $\mu\text{m}$ ), starting with thinner substrates in the inner parts of the mirror and progressively thicker substrate toward the outer diameter of the mirror to reduce distortion. X-rays from sources outside the field of view are reduced by stray light baffles (pre-collimators) made of cylindrical aluminum shells aligned above each reflector shell. A thermal shield was attached to the front of the pre-collimator to stabilize the thermal environment of the XMA. The thermal shield was made of 0.22 micron-thick aluminized polyimide film on a stainless-steel mesh to provide the necessary strength and high X-ray throughput.

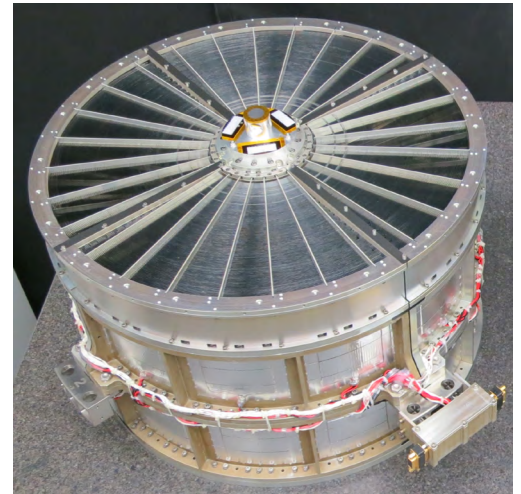

NASA

Focal length	Diameter	Number of Shells
5.6 m	45 cm	203



Installing the XMA to the spacecraft

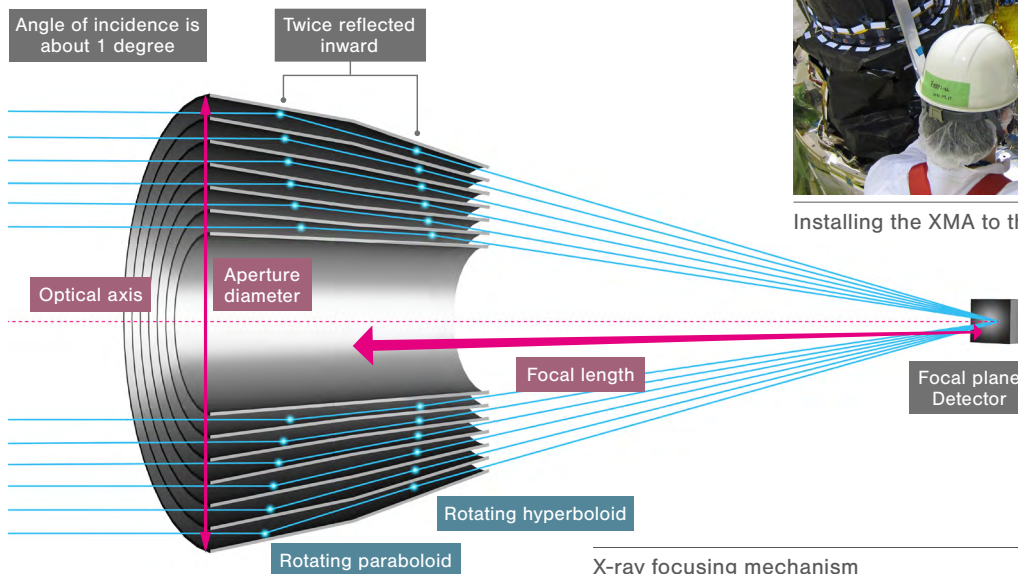

X-ray focusing mechanism

# Mission Instruments

## XMA



NASA

The reflectors for the XMA were made by dividing the circumference into four sections. Each of the two XMA units required 1,624 mirror segments. It took five technicians about a year and a half to fabricate a sufficient number of segments to construct the two XMA units. The reflectors were fabricated using the epoxy replica method. In this method, gold was deposited on the surface of a glass tube, which was inexpensive and smooth enough to reflect X-rays, and then peeled off with an aluminum substrate coated with an epoxy adhesive to make the reflectors. By eliminating the polishing process, the production cost was significantly reduced. The photo shows a row of glass tubes with gold deposited on their surfaces.

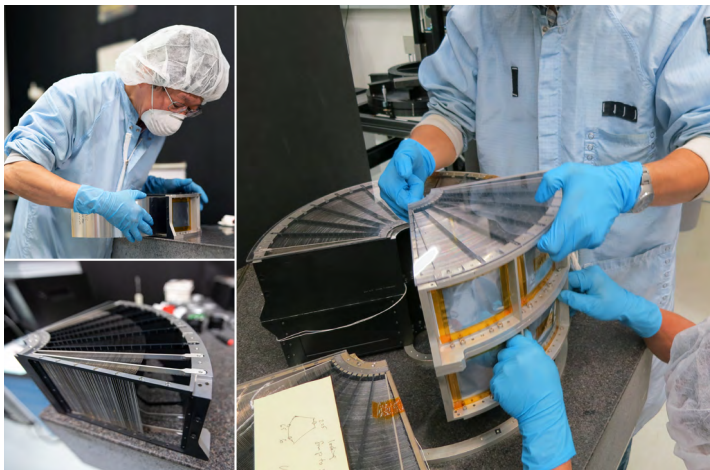

NASA

The reflectors were held in the XMA housing by beams with a tooth-like structure. One by one, the reflectors were manually inserted into the grooves of the comb teeth (left photo). After all the reflectors were inserted, the position of the beams was adjusted radially to align the reflectors with the designed locations. Finally, the eight adjusted housings were assembled to form the complete XMA. Although this assembly was done entirely by hand, we were able to adjust the housings to within 100  $\mu\text{m}$  of the correct position.

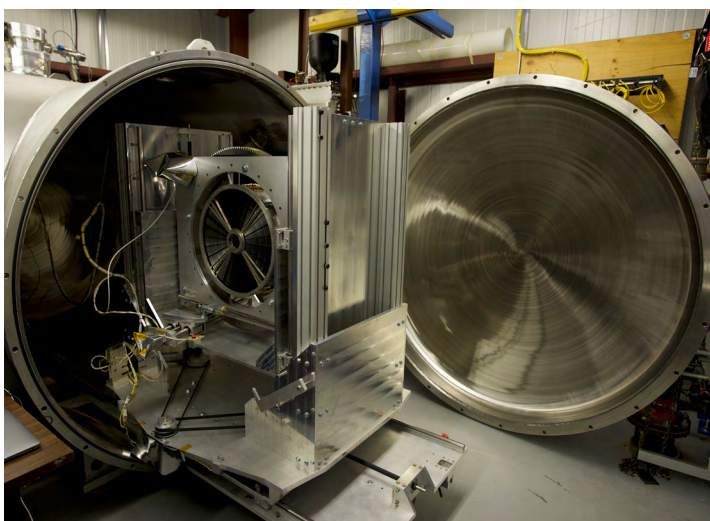

NASA

The pre-collimator, heat shield, and heater were mounted on top of the completed XMA (only the heat shield was mounted just before delivery to the satellite). The XMA was ready for shipment after undergoing environmental tests such as thermal cycling, vibration tests, and several months of X-ray irradiation tests. The photo shows XMA being installed in the vacuum chamber of the 100-m X-ray beamline at NASA's Goddard Space Flight Center for X-ray irradiation testing. The data from the calibration test will be used to interpret data obtained from astronomical observations.

# Mission Instruments

## Resolve

Soft X-ray spectrometer for ultra-precise energy measurement

### The Basics

Resolve is a precision spectrometer with a 6×6-pixel X-ray microcalorimeter array at the focus of an X-ray mirror assembly (XMA). It provides unprecedented energy resolution ( $\Delta E \leq 7$  eV at 6 keV) over a wide observation bandwidth of 0.3-12 keV. It is a non-dispersive spectrograph that can precisely observe point sources (e.g., neutron stars) and extended sources (e.g., galaxy clusters and supernova remnants).

### Technology

**Detector:** A microcalorimeter detector array of 36 pixels detects minute temperature rises caused by incident X-ray photons. It consists of an X-ray absorber made of mercury telluride (HgTe) and a silicon semiconductor thermometer, which is cooled to  $-273.1^\circ\text{C}$  (0.05 Kelvin) to achieve high-resolution spectroscopy. Non-X-ray events created by cosmic rays passing through the detector are identified and eliminated by a semiconductor detector placed behind the array.

**Cooling system:** The cooling system consists of an adiabatic demagnetizing refrigerator (ADR), superfluid helium, a mechanical refrigerator, and a vacuum-insulated container (dewar) that houses and mounts the refrigerators to achieve the detector's operating temperature (0.05 Kelvin). The superfluid helium is gradually consumed in orbit, but even after depletion, scientific observations can continue due to the cryogen-free capability designed into the instrument.

**Filter wheel:** Three types of X-ray attenuation filters will be installed to enable observation of the brightest celestial objects. It also has a radiation isotope (Fe-55) and modulated X-ray sources (MXS) for in-orbit energy calibration.

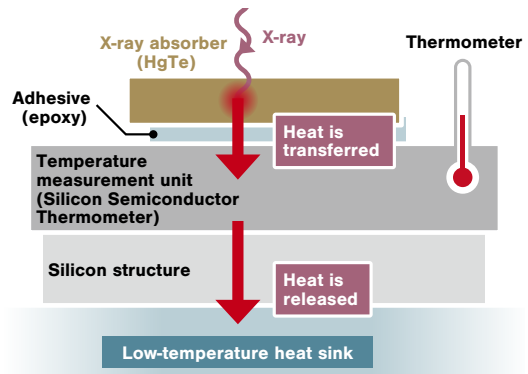

Mechanism of energy measurement. Figure corresponds to one pixel of the detector.

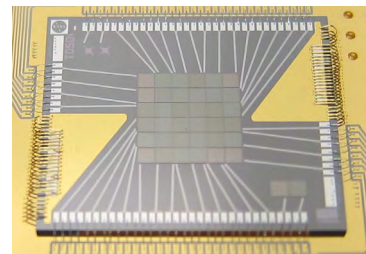

Photograph of the detector. The 6×6 pixel in the center measures 5mm × 5mm

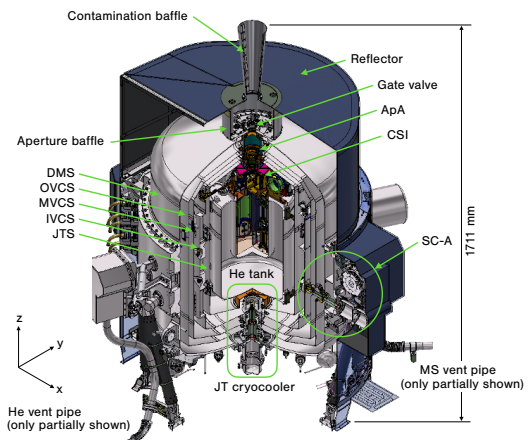

Cooling System. Dewar's multi-layer shielding, multi-stage refrigerator, and superfluid helium cool the detector (inside the CSI) to 0.05K.

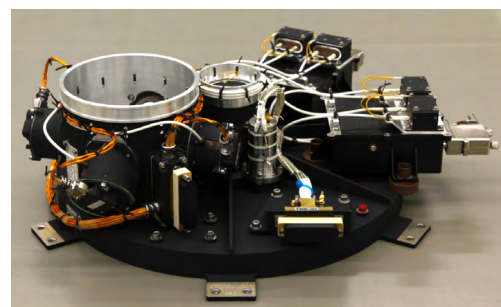

Filter wheel. Four MXS in four locations on the left ring side.





---

# Mission Instruments

## Xtend

Soft X-ray imaging system that takes images over a wide wavelength range

### The Basics

Xtend's detector is a Japan-manufactured Soft X-ray Imager (SXI). Xtend has a field of view of  $38 \times 38$  arcmin, the largest ever for an X-ray telescope, and can observe a field of view larger than the full moon at once. It has an advantage in the observations of extended objects. In addition, Xtend can support Resolve's observations by capturing objects outside its field of view.

### Technology

**CCDs:** Using a thick depletion layer, the Xtend's CCD can detect higher energy X-rays than conventional X-ray CCDs. The fully depleted back-illuminated element has high quantum efficiency for low-energy X-rays. The transfer electrode surface is not exposed to the outside world. It is highly resistant to micrometeorite impact and radiation damage, which can cause functional failure.

**Cooler:** Xtend's CCDs are cooled to  $-110^\circ\text{C}$  using a single-stage Stirling refrigerator. This not only suppresses dark currents but also reduces performance degradation effects due to radiation damage.

**ASIC:** Xtend is equipped with a dedicated ASIC (Application-Specific Integrated Circuit) that universities developed over ten years. This allows the CCD output signal to be read out efficiently and with low power consumption.

**Improvements:** Xtend's CCD design is almost the same as that of ASTRO-H, a JAXA predecessor mission that ended prematurely in 2016, but two improvements have been made. The CCD's internal potential structure has been modified to achieve higher charge transfer efficiency and improved radiation tolerance. Furthermore, visible light shielding performance is improved. The shield suppresses the generation of false signals originating from stray light in orbit.

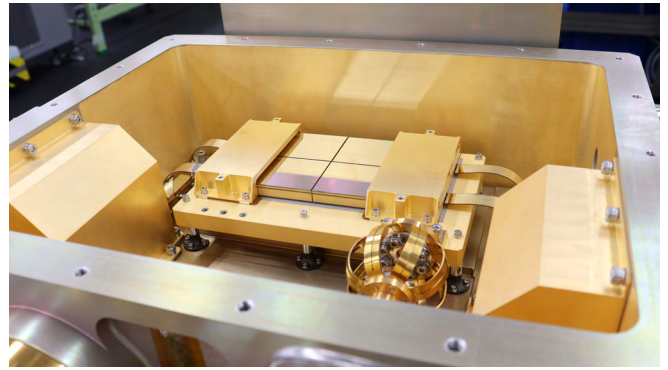

CCD chips of Xtend. The silver part is the light-receiving surface.



Xtend being inspected prior to satellite mounting

# Mission Instruments

## Xtend



A screening test was conducted to select the best CCD chips to be installed in the satellite from many candidate elements. In this test, we picked the four best CCDs for the flight by scoring various evaluation axes, such as energy resolution and noise characteristics. Researchers and students from all over Japan worked together to carry out multiple tests and simultaneously analyze data for performance evaluation.

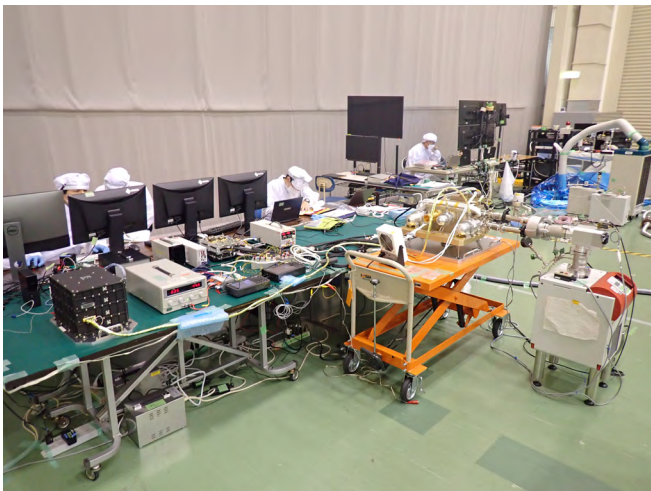

The selected elements were assembled into the flight housing and electronics, and then tested for integration and performance evaluation of the imaging system. The X-ray CCD camera requires the devices to be cooled below  $-100^{\circ}\text{C}$  to reduce thermal noise, and the camera housing is evacuated to prevent condensation.

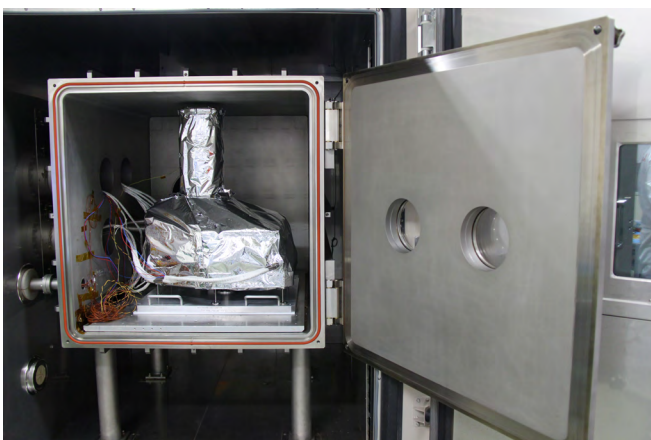

Before installation on the spacecraft, Xtend had to pass mechanical environmental tests to ensure that it would maintain its imaging performance under the harsh space environment and vibrations experienced during launch. The completed flight camera was subjected to a thermal vacuum test to simulate the orbital temperature environment and a sound and vibration test to simulate launch conditions to confirm that there was no change in performance before and after the tests. The series of tests were conducted at JAXA's experimental facility, where young researchers and many students played an active role. Xtend was then handed over to the satellite system in perfect condition.

# Science Operation

## Toward Creating Scientific Results

### The Basics

After the initial operations and performance verification phase of scientific observations, XRISM will be open to the world as an observatory for international public observations. We believe that it is vital for XRISM to maximize its scientific output to make XRISM data available to scientists from various backgrounds, not just members of the satellite development team. Experts review observation proposals from guest observers, and XRISM observes the selected objects. The raw observation data will be converted to calibrated data and distributed to the proposer. XRISM Science Operations Team supports guest observation proposals and scientific observation plans, standardizes the format of observation data, performs calibration, and provides helpdesk services. The quality of XRISM's scientific output depends on the quality of XRISM's Science Operations.

### System and Technology

XRISM science operations are carried out in cooperation with the data centers at JAXA, NASA, and ESA, where observation proposals are publicly solicited and accepted by the three space agencies. Then, the selected proposals are compiled into a detailed daily operation plan at JAXA, the site of satellite operations. The XRISM data will then be converted to an astronomical standard data format in Japan and sent to the United States for calibration and processing. The data are then distributed and archived in Japan and the United States for easy handling by observers. The key is to ensure that the data and analysis tools incorporate all of the expertise and knowledge of the satellite developers and that they are easy to handle.

Accurately determining the on-orbit characteristics of onboard instruments is called calibration. Calibration is critical to improve the accuracy of spectral imaging capability. It cooperates with Science Operation Team (SOT) together with the Resolve and Xtend development teams. It is then made available to the public in a form that guest observers can use. SOT will also document the information needed for the analysis. SOT will then manage the website for researchers. After the data are presented to the guest observers, helpdesks in Japan, the U.S., and Europe will support the analysis process.

Furthermore, with the support of the Japan Society for the Promotion of Science (JSPS), XRISM is developing a project to strengthen the creation of scientific results and foster the next generation of young researchers through international collaboration. International symposia are held in Japan, the U.S., and Europe to promote exchanges with other wavelengths and theoretical researchers.

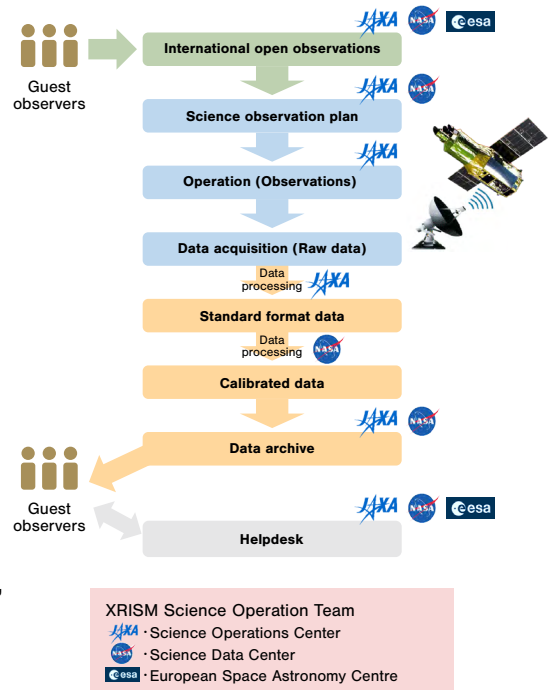

---

# Science Operation

## Toward Creating Scientific Results

### Development Overview

For XRISM science operations, we are utilizing positive aspects of the ASCA, SUZAKU, and ASTRO-H science operations while improving areas that had been overlooked. We worked with several subteams to refine the plan. We have prepared for the post-launch science operations by developing new operation tools to improve maintainability while taking advantage of the ASTRO-H's assets, optimizing the knowledge gained from the development of the onboard instruments, and improving the analysis for more accurate analysis.

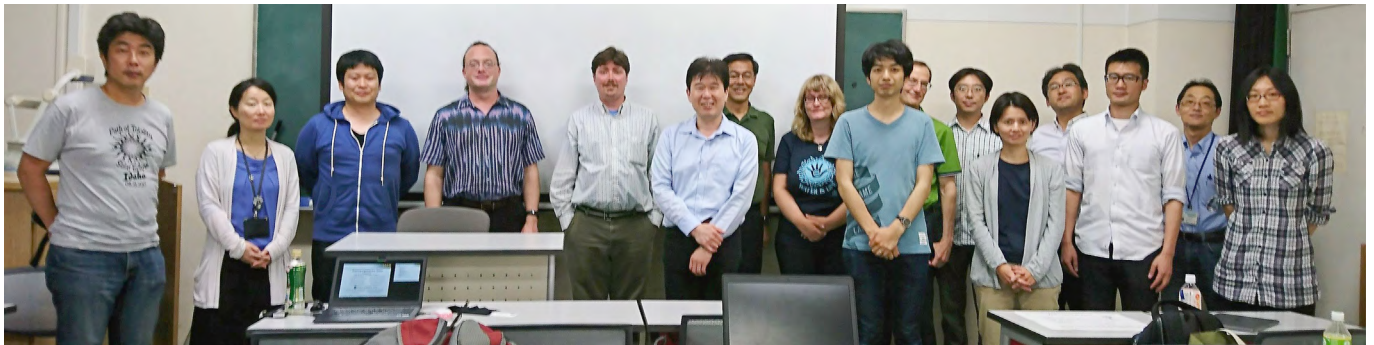

### Scientific Operations Team

The XRISM Science Operations Team was organized during the XRISM Team Meeting held in Nara, Japan in May 2018. The team started with Japanese and U.S. members. Since then, the team has been preparing together, sharing information through weekly conference calls between Japan and the United States. It is a challenging international cooperation because of the 13-14 -hour time difference. As of 2023, we have a large group of nearly 30 members on the Japanese side alone.



### Scientific Operations Readiness Boot Camp

The development of scientific operation tools has been conducted through online discussions, debugging, and validation by developers meeting. To facilitate smooth communication, the developers have gathered at JAXA once or twice a year for discussions and to work each development and validation milestone, called "Boot Camps." The photo was taken at the camp in September 2022.



### Comprehensive Operability Test

In the final stage of preparation for scientific operations, a rehearsal simulating actual processes was necessary after the tools and procedures were completed. The photo shows the comprehensive operability test conducted in November 2022. Satellite and scientific operations personnel are working together. Through repeated rehearsals and training, preparations have been made to ensure that science operations will be reliable after XRISM is in orbit.

---

# Science Operation

## Satellite Operations and Ground Systems

### Operation

XRISM will operate using the antenna (USC station) at the Uchinoura Space Center (USC) as its main station. Although each communication time is only about 10 minutes, the USC station communicates with XRISM 4-5 times daily to check satellite status, replay recorded data, and send satellite control commands.

In addition, the XRISM team strengthened the satellite monitoring system based on the lessons learned from the anomalies during the ASTRO-H operation. The satellite will be monitored by JAXA ground stations and NASA ground stations as much as possible, for 10 minutes every 3 to 4 hours.



Testing of the ground systems

### Development

Learning from the anomalies that occurred during the operation of ASTRO-H, XRISM has introduced several features to the ground operation system to ensure safe and reliable operation.

The first is the satellite simulator. This simulator simulates the onboard computers for data processing, attitude, and orbit control and runs the same software. The simulator is used for initial rehearsals of critical operations, as well as for confirming operational feasibility and for training.

The other is the satellite automatic monitoring system, which can immediately detect satellite anomalies. The software is common to all JAXA space science satellites and is already in use on current satellites, but monitoring rules will be developed for XRISM and refined through ground tests.

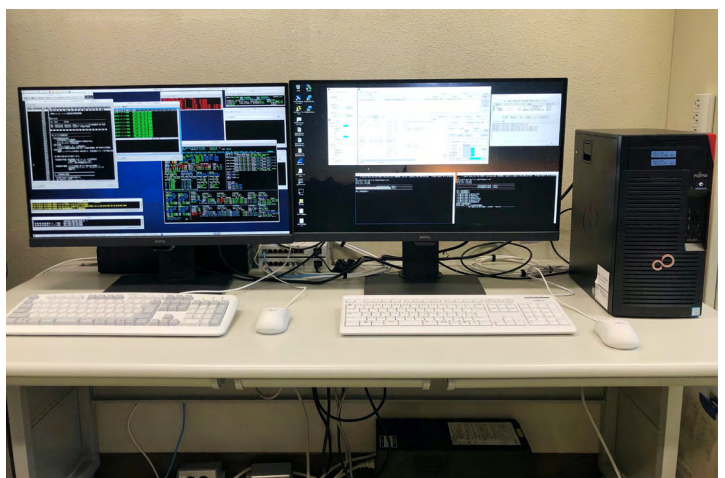

Satellite simulator. The left terminal sends commands to the satellite simulator, while the right is the satellite simulator itself.

# XRISM Team

## Participating Organizations

Japan Aerospace Exploration Agency (JAXA), National Aeronautics and Space Administration (NASA),

European Space Agency (ESA), Tokyo Metropolitan University, Kanto Gakuin University, Miyazaki University, Saitama University,

SRON (Netherlands Institute for Space Research), University of Geneva, Canadian Space Agency,

Chuo University, Ehime University, Fukuoka University, Fujita Medical University, Hiroshima University, Kagoshima University, Kanazawa University, Kansai Gakuin University, Kinki University, Konan University, Kyoto University, Nagoya University, Nara University of Education, Nara Women's University, Japan Welfare University, Osaka University, RIKEN, Rikkyo University, Rikkyo University, Shibaura Institute of Technology, Shizuoka University, Tohoku Gakuin University, University of Tokyo, Tokyo University of Science, Waseda University, University of Teacher Education, Kumamoto Gakuen University, Meiji University, Gravitation AstroParticle Physics Amsterdam, Canadian Light Source Inc., University of Chicago, University of Durham, European Southern Observatory, Harvard-Smithsonian Center for Astrophysics, Lawrence Livermore National Laboratory, Leiden University, University of Maryland, Massachusetts Institute of Technology, University of Michigan, Saint Mary's University, University of Waterloo, University of Wisconsin, Yale University

Project Manager	Hironori Maejima	JAXA/ISAS
Principal Investigator	Makoto Tashiro	JAXA/ISAS, Saitama University
Project Engineer	Ken-ichi Toda	JAXA/ISAS
Project Scientist	Kyoko Matsushita	Tokyo University of Science
deputy Project Scientist	Hiroya Yamaguchi	JAXA/ISAS
Project Manager	Lillian Reichenthal	NASA/GSFC
co-PI	Richard Kelley	NASA/GSFC
Mission Systems Engineer	Leslie Hartz	NASA/GSFC
Mission Scientist	Robert Petre	NASA/GSFC
Project Scientist	Brian Williams	NASA/GSFC
Project Scientist	Matteo Guainazzi	ESA
deputy Project Scientist	Elisa Costantini	SRON

### Resolve

Instrument Manager (JAXA)	Yoh Takei	JAXA/ISAS
Instrument PI (JAXA)	Yoshitaka Ishisaki	Tokyo Metropolitan University, JAXA/ISAS
Instrument sub-PI (JAXA)	Ryuichi Fujimoto	JAXA/ISAS
Instrument sub-PI (JAXA)	Masahiro Tsujimoto	JAXA/ISAS
Instrument Manager (NASA)	Lillian Reichenthal	NASA/GSFC
Instrument PI (NASA)	Richard Kelley	NASA/GSFC
Lead Instrument Systems Engineer (NASA)	Gary Sneiderman	NASA/GSFC

### Xtend

Instrument Manager	Hiroshi Tomida	JAXA/ISAS
Instrument PI	Koji Mori	Miyazaki University, JAXA/ISAS
Instrument sub-PI	Hiroshi Nakajima	Kanto Gakuin University, JAXA/ISAS
Former Instrument PI	Kiyoshi Hayashida	(Osaka University)

### Science/Mission Operations

Science Operation Center Lead (JAXA)	Yukikatsu Terada	Saitama University, JAXA/ISAS
Science Data Center Lead (NASA)	Matt Holland	NASA/GSFC
Mission Operations Lead	Shin Watanabe	JAXA/ISAS

### In Flight Calibration Planning

Lead	Eric Miller	MIT
co-Lead	Makoto Sawada	Rikkyo University

### Laboratory Astrophysics

Chair	Timothy Kallman	NASA/GSFC
Vice Chair	Jelle Kaastra	SRON

### Science target category

Galactic Compact chair	Chris Done	Durham University
Galactic Compact co-chair	Teruaki Enoto	Kyoto University
Galactic Diffuse chair	Aya Bamba	University of Tokyo
Galactic Diffuse co-chair	Paul Plucinsky	Harvard-Smithsonian CfA
Extra-Galactic Compact chair	Yoshihiro Ueda	Kyoto University
Extra-Galactic Compact co-chair	Erin Kara	MIT
Extra-Galactic Diffuse chair	Irina Zhuravleva	University of Chicago
Extra-Galactic Diffuse co-chair	Yutaka Fujita	Tokyo Metropolitan University

(As of June 2023)